

USER MANUAL



TEKNA-S PLUS
MONITOR



INTRODUCTION

First of all, we thank and congratulate you for purchasing this product manufactured by Golmar. Our commitment to achieving the satisfaction of customers like you is manifested through our ISO-9001 certification and the manufacture of products like the one you have just purchased. Its advanced technology and strict quality control will ensure that customers and users enjoy the numerous features that this device offers. To get the most out of them and ensure proper operation from day one, we recommend that you read this instruction manual.

CONTENTS

Introduction..... 2

Contents..... 2

Safety precautions..... 2

Characteristics..... 3

System operation..... 3

Description of the monitor.....

 Description..... 4

 Status LED and description of the connection terminals..... 4

 Function buttons..... 5

 Communication with hearing aids..... 5

 SW1 DIP switch..... 6

 Description of the identification label..... 6

 RJ-45 connector (installation with UTP cable)..... 7

 End of line jumper and EL-562S module..... 7

 Installing the monitor in a wall mounting connector..... 8

 Installing the monitor in an embedding box..... 9

Monitor programming..... 10-11

Rapid monitor programming..... 11

Advanced programming (monitor functions).....

 Menu 1..... 12

 - Activating/deactivating the doctor mode function..... 12

 - Changing the ringtone melody..... 12

 Menu 2..... 13

 - Changing the function of button B..... 13

 - Changing the function of button C..... 13

 - Intercom with Tekna Plus monitors..... 13

 Menu 3..... 14

 - Repeating the ringtones..... 14

 - Adjusting the 'door panel communication time'..... 14

 - Adjusting the 'door panel call' time..... 14

 - Activating the in-call video..... 14

 Menu 4..... 15

 - Setting all of the monitor's advanced programming options to the 'default setting'..... 15

Optional connections.....

 - Activating auxiliary devices..... 16

 - Input for auxiliary button to activate the door panel lock release..... 16

 - Intercom within an apartment..... 17

 - Button for receiving calls from the apartment front door..... 17

 - Activating a second camera..... 18

Cleaning the monitor..... 18

Wiring diagrams..... 19-20

Notes..... 21

Compliance..... 22











SAFETY PRECAUTIONS

- Avoid overtightening the screws of the monitor connector.
- **Always disconnect the power supply** before installing or making modifications to the device.
- The fitting and handling of these devices must be carried out by **authorised personnel**.
- All of the wiring must run at least **40cm away from any other wiring**.
- Install the monitor in a dry protected location free from the risk of dripping or splashing water.
- Do not place in humid, dusty or smoky locations, or near sources of heat.
- Before connecting the device to the mains, check the connections between the door panel, power supply, distributors and monitors.
- Always follow the instructions contained in this manual.

CHARACTERISTICS

- Monitor for Plus / Uno installation.
- 4.3" TFT colour screen.
- Monitor with 3 common wires plus coaxial cable.
- Monitor with 4 common wires plus twisted pair.
- Monitor with UTP cabling plus RJ-45 connector.
- Enables communication with hearing aids equipped with T-mode, making conversation possible (inductive loop).
- Function and advanced programming buttons (to customise the monitor's functions).
- Completely private conversation and image.
- Auto switch-on function.
- Auto spy function without occupying a channel.
- 'Doctor mode' function (automatic door opening, see p. 12).
- Intercom between two devices in the same apartment.
- Input for calls from the apartment front door.
- Call volume control (maximum, no volume 'night mode,' medium and minimum. See p. 5).
- Input for outside door release button.
- Output to auxiliary call repeater.
- Call to primary and secondary guard unit.
- Panic call to guard units.
- Different ringtones to identify call origin: Door panel, guard unit, intercom and interior door of the apartment.
- Activation of two auxiliary functions: second camera, courtesy lights, etc.
- Control of brightness and colour.
- DIP switches for setting the monitor address, 'call code' and master/slave (quick programming mode).
- Door release button.
- Monitor status LED.
- Programming LED.

SYSTEM OPERATION

- To make a call, the visitor presses the button for the apartment, a number of audible tones indicate that the call is being made and LED  on the door panel illuminates. At this moment, the apartment's monitor (telephone) receives the call. If the visitor presses the button for another apartment by mistake, the call can be cancelled by pressing the button for the correct apartment.
- In systems with several access doors, the other door panel(s) automatically disconnects; if another visitor attempts to call, a number of telephone tones will indicate that the channel is busy and LED  on the door panel will illuminate.
- General panels (EL501 mode): If the call is being made from the general entrance door panel, the interior door panel of the building being called and other possible general entrance door panels automatically disconnect. If another visitor attempts to call from either a busy interior door panel, a number of telephone tones will indicate that the channel is busy and LED  of the door panel will illuminate, or from another general entrance door panel, a number of telephone tones will indicate that the channel is busy and LED  of the general entrance door panel will blink for 3 seconds. The door panels of the other interior buildings will remain free to be used.
- General panels (EL501 mode): If the call is made from an interior panel, the other interior panels will remain free to be used. It is only possible to make calls to interior buildings from the general entrance door panels when their door panels are not in use. If an attempt is made to make a call to a busy interior door panel, a number of telephone tones will indicate that the channel is busy and LED  of the general entrance door panel will blink for 3 seconds.
- The call lasts for 45 seconds, during which time an image appears on the apartment's monitors for 2 seconds after the call is received without the visitor knowing, and the status LED on the master monitor will illuminate (green). If the call is not answered within 45 seconds, the master monitor's status LED will illuminate (red), LED  on the door panel will turn off and the channel will become free.
- To establish communication, lift the handset of the monitor, and the monitor's status LED (green) and the door panel's LED  will illuminate. Communication with hearing aid : The handset enables communication with hearing aids equipped with T-mode, making conversation possible (inductive loop).
- Communication will last for one and a half minutes or until the handset is hung up. After communication, the monitor's status LED will illuminate (red), the door panel's LED  will turn off and the channel will be free.
- To open the door, press the door release button during the call or communication processes: one press will activate the door release for 3 seconds and LED  on the door panel will also illuminate for 3 seconds.
- A description of the function buttons can be found on p. 5.

DESCRIPTION OF THE MONITOR

Description of the Tekna S Plus monitor:

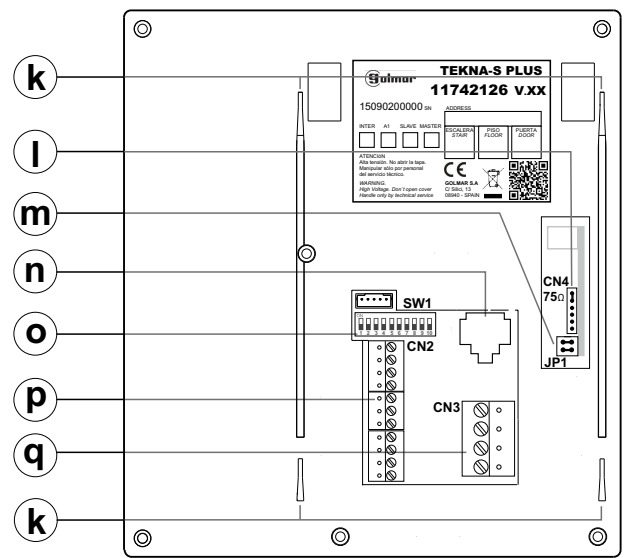
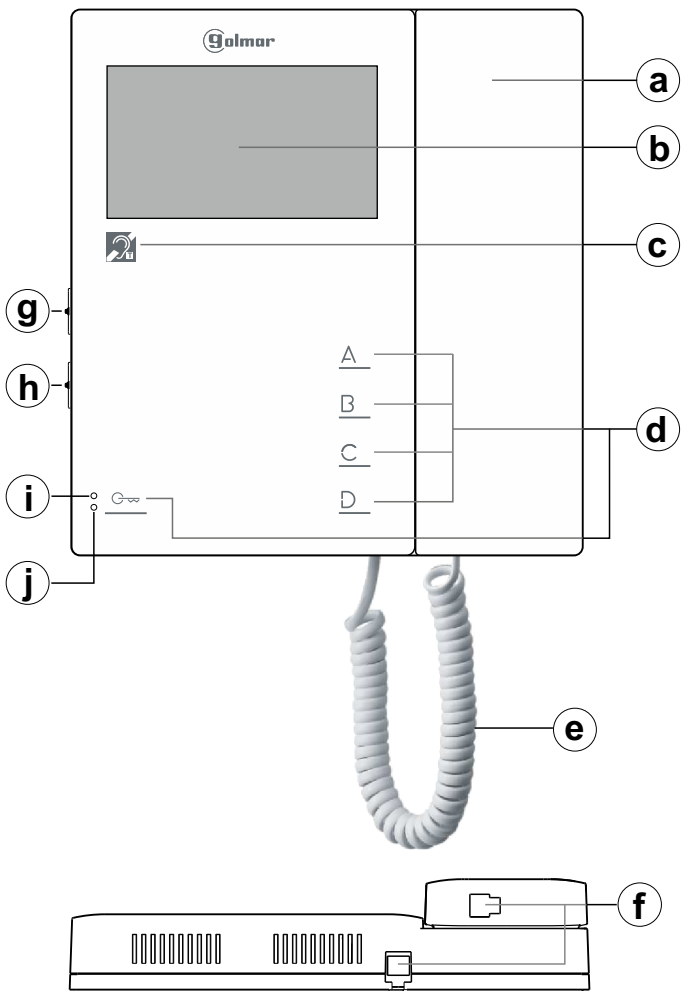

- a. Handset.
- b. 4.3" TFT colour screen.
- c. Communication with hearing aids. Set the hearing aid switch to position T.
- d. Function/programming buttons.
- e. Telephone cord.
- f. Conector para cordón.
- g. Cord connector.
- h. Colour control.

- i. Advanced programming LED.
- j. **Monitor status LED (two-colour):**
 - In standby: LED illuminated red.
 - Call: LED illuminated green (master monitor).
 - Communication: LED illuminated green.
 - Auto spy if Bus busy: LED blinking red rapidly.
 - No volume (night mode): LED blinking red.
 - Doctor mode: LED blinking green.
- k. Connector fixings.
- l. CN4 connector (end of line jumper).
- m. JP1 jumper, remove in video installation with twisted pair (see 'EL562S module' p. 7).
- n. RJ-45 connector (installation with UTP cable).
- o. SW1 configuration switches.
- p. CN2 connection terminals.
- q. CN3 connection terminals.

Description of the connection terminals:

CN3 connection terminals:

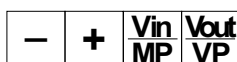

- , + : Negative, positive (18Vdc power supply).
- Vin : Video signal input through coaxial cable.
- : Coaxial cable mesh.
- Vout : Video signal output through coaxial cable.
- Vp, Mp : Balanced video signal (through twisted pair).

CN2 connection terminals:



- A : Audio communication.
- D : Digital communication.
- HZ- : Door bell button input.
- AP+ : Input for auxiliary door opening button.
- INT : Intercom function.
- 2C : Output for 2nd camera activation.
- A1 : Output (negative) for auxiliary device activation (max. consumption 50mA).
- SA : Output (negative) for auxiliary call repeater (max. consumption 250mA).

DESCRIPTION OF THE MONITOR

Function buttons:

- A** One long press for 2 seconds: with the monitor in standby and the handset on the hook, this activates ringtone volume mode, with a tone indicating the volume selected. Then each long 2-second press (before 5 seconds elapse) selects a volume level: maximum, no volume 'night mode,' minimum and medium, and so on (carousel mode). Note: The 'night mode' status LED blinks red. During a call, the monitor does not emit a ringtone unless it is an 'apartment front door call.'
- One long press for 3 seconds: with the monitor in standby and the handset on or off the hook, this turns the monitor off. Then one short 1-second press turns on the monitor. After any resetting of the monitor and for the following 45 seconds, no operation with it can be performed.
- One long press for 3 seconds during a call cancels the call on the monitor. If there are more monitors in the apartment, they will continue with the ringtones of the door panel. During communication with the door panel, the communication in progress will end.
- (*) **B** With the monitor in standby and the handset off the hook, this activates the intercom function (in the same apartment). One long press until a confirmation tone can be heard will call all of the monitors in the apartment. To call individual devices, press the button once to call the 'master' monitor, twice to call 'slave 1,' 3 times to call 'slave 2,' 4 times to call 'slave 3' and 5 times to call 'slave 4.' This selective intercom call mode is only available with Tekna Plus SE, Tekna HF Plus and Tekna S Plus monitors. This only functions if no call or communication is in progress.
- (*) **C** Regardless of the position of the handset, this activates auxiliary device 'A1.'
- D** With the monitor in standby and the handset on the hook, this enables the image from the door panel configured as main to be viewed (if the bus is busy, the status LED of the monitor will indicate so with a few quick blinks). With the handset off the hook, this enables audio and video communication with door panels that have their auto switch-on function activated to be established. This only functions if no communication is in progress.
- In call, a slave monitor enables the image of the door panel to be captured.
-  With the monitor in standby and the handset on the hook, this makes a panic call to the guard units configured to receive such calls. With the handset off the hook, it enables a normal call to be made to the main guard unit. During call reception and communication processes, it enables the lock release to be activated.

(*) In advanced programming mode, the default functions of function buttons **B** and **C** can be changed with one of the following functions at the same time and per button: 'intercom,' 'auxiliary device A1 activation,' 'second camera 2C activation' or 'call to secondary guard unit' (see p. 13).

Communication with hearing aids:

The handset of the Tekna-S Plus monitor enables communication with hearing aids equipped with T-mode, making conversation possible (inductive loop).

Remember: Set the hearing aid switch to position T.

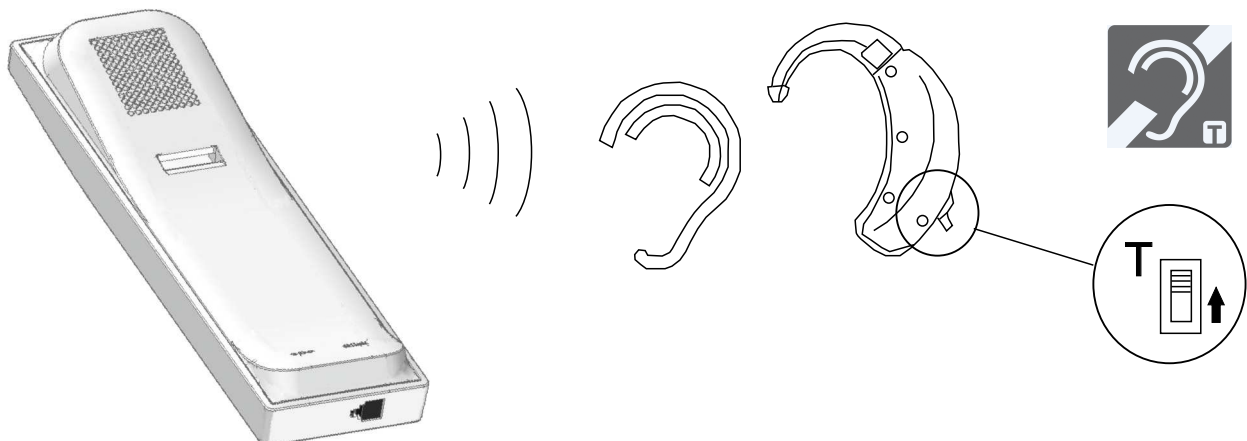

DESCRIPTION OF THE MONITOR

Description of the SW1 DIP switch:

The SW1 DIP switch is located at the back of the monitor on the right-hand side. It enables the monitor to be configured as master/slave and an address to be assigned.

Important: This type of programming cannot be performed on a general entrance door panel.

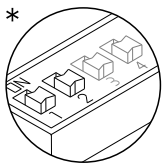
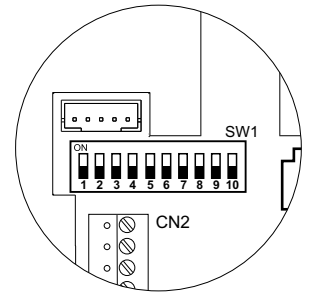

DIP 1 and DIP 2: Sets the monitor as master/slave + intercom. DIP 1 and DIP 2 to OFF master, DIP 1 to OFF and DIP 2 to ON slave 1, DIP 1 to ON and DIP 2 to OFF slave 2, DIP 1 and DIP 2 to ON slave 3.

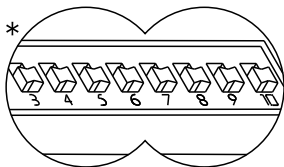

DIP 3 to DIP 10: To set the monitor address (addresses 1 to 255). The switches set to OFF have a zero value. The values of the switches set to ON are shown in the table below. The monitor code is the sum of the values of the switches set to ON.

Switch number:	3	4	5	6	7	8	9	10
Value when ON:	128	64	32	16	8	4	2	1

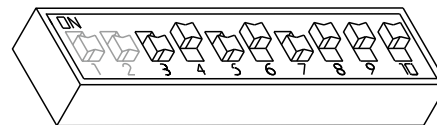

Example: 0+64+0+16+0+4+2+1=87

***Factory setting**

Description of the identification label:

golmar **TEKNA-S PLUS**
11742126 v.XX

00000000000 SN ADDRESS

INTER	A1	SLAVE	MASTER
<input type="checkbox"/>	<input type="checkbox"/>	<input type="checkbox"/>	<input type="checkbox"/>

ESCALERA STAIR	PISO FLOOR	PUERTA DOOR
-------------------	---------------	----------------

ATENCIÓN
Alta tensión. No abrir la tapa.
Manipular sólo por personal del servicio técnico.

WARNING.
High Voltage. Don't open cover
Handle only by technical service

CE GOLMAR S.A
C/ Silici, 13
08940 - SPAIN

To facilitate repair, replacement or the addition of monitors to the existing installation, fill in the label with the relevant information.

- MASTER: main monitor.
- SLAVE: slave monitor.
- INTER: secondary monitor with intercom function.
- A1: monitor connected to an auxiliary device.
- CODE: call button code.
- STAIRWAY: code of the channel (building).

DESCRIPTION OF THE MONITOR

Description of the RJ-45 connector (installation with UTP cable):

The monitor features an RJ-45 connector for installation with a UTP cable. It is located at the back of the monitor on the right-hand side. It enables connection of the system's main communication wires (**+, -, A, D, Vp and Mp**) in twisted-pair installations.

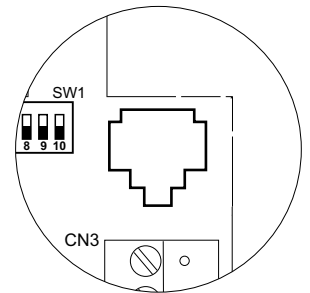

RJ-45 equivalence table

Pin	Ethernet cable	Golmar connection
1	White + Orange	GND (Audio)
2	Orange	Audio
3	White + Green	GND (Data)
4	Blue	+18V
5	White + Blue	+18V
6	Green	Data
7	White + Brown	Vp
8	Brown	Mp

RJ-45 connector (cable type: T568B)

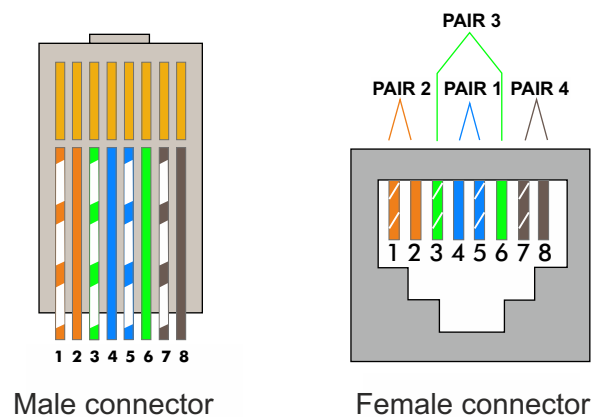

MONITOR SETTINGS

Handling of the end of line jumper:

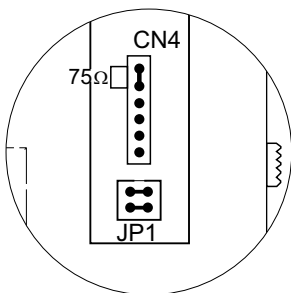

The end of line jumper is located on the CN4 connector at the back of the monitor on the right-hand side. In the case of twisted pair installations, the end of line jumper is located on the EL562S module (see next section). Do not remove the jumper if the video cable ends in the monitor. Remove the jumper if the video cable continues after the monitor.

EL-562S module for video door entry system installations with twisted pair cable:

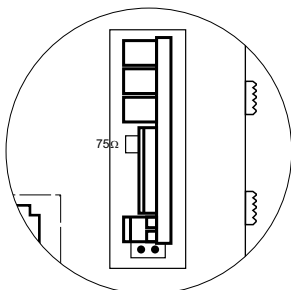

Locate the CN4 connector at the back of the monitor on the right-hand side. To insert the EL-562S module, first remove the jumper located in the CN4 connector and JP1 of the monitor.

NOTE: In this type of installation, set the SW1-3 DIP switch on the sound module of the door panel to ON, see the **T632/Plus P/T** instruction manual (p. 13) or set the SW1-3 DIP switch of the EL500SE microprocessor to ON, see the **T5000 ML** manual (p. 7). The door panel of the SV801SE GRF kit does not require modification. Use the specific wiring diagram.

INSTALLING THE MONITOR IN A WALL MOUNTING CONNECTORE

Avoid dusty or smoky environments or locations near sources of heat.

Positioning the wall mounting connector:

The top of the connector must be positioned at a height of 1.60 m. The minimum distance between the sides of the connector and the closest object must be 5 cm.

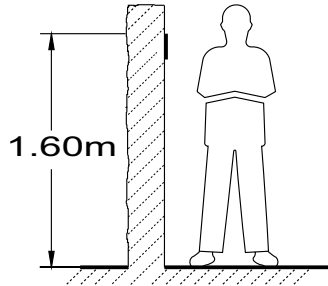

Fixing the monitor's wall mounting connector to the wall:

Fix the monitor's wall mounting connector to the wall by drilling two 6mm diameter holes and using the screws and plugs supplied with the terminal.

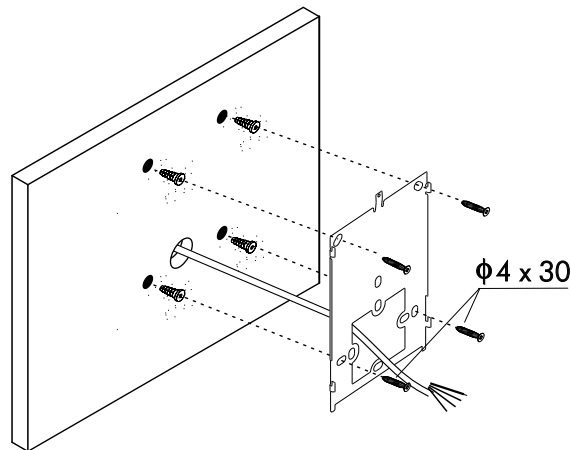

Positioning the monitor:

Connect the cables to the monitor (see p. 4), position the monitor in front of the wall mounting connector, ensuring that the holes in the base of the monitor line up with those on the connector ①, and then move the monitor downwards ② until the monitor is securely fixed to the connector ③.

Remember to remove the protective covering from the front of the monitor once installation is complete.

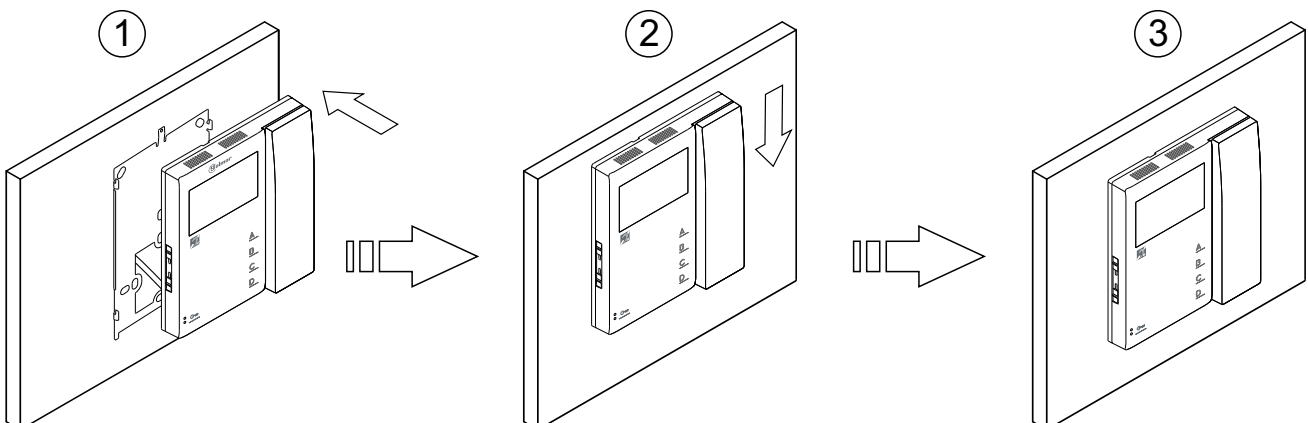

INSTALLING THE MONITOR IN AN EMBEDDING BOX

Avoid dusty or smoky environments or locations near sources of heat.

Location of the embedding box:

Make a hole in the wall to position the top of the universal embedding box at a height of 1.60 m from the ground. The minimum distance between the sides of the embedding box and the closest object must be 5 cm.

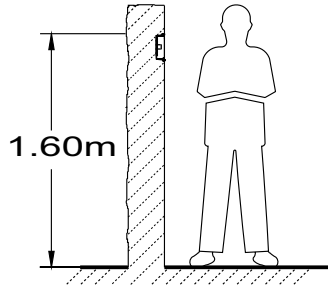

Positioning the embedding box and fitting the wall mounting connector:

Pass the cable through the hole made in the embedding box. Embed the box and ensure that it is level and flush. Fix the wall mounting connector of the monitor to the embedding box with the screws supplied.

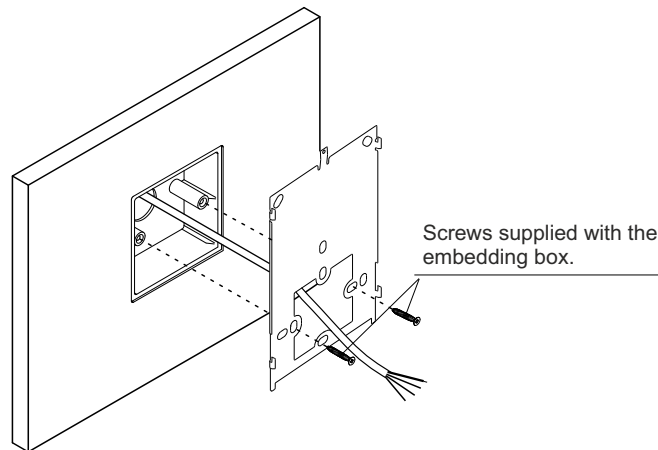

Positioning the monitor:

Connect the cables to the monitor (see p. 4), position the monitor in front of the wall mounting connector, ensuring that the holes in the base of the monitor line up with those on the connector ①, and then move the monitor downwards ② until the monitor is securely fixed to the connector ③.

Remember to remove the protective covering from the front of the monitor once installation is complete.

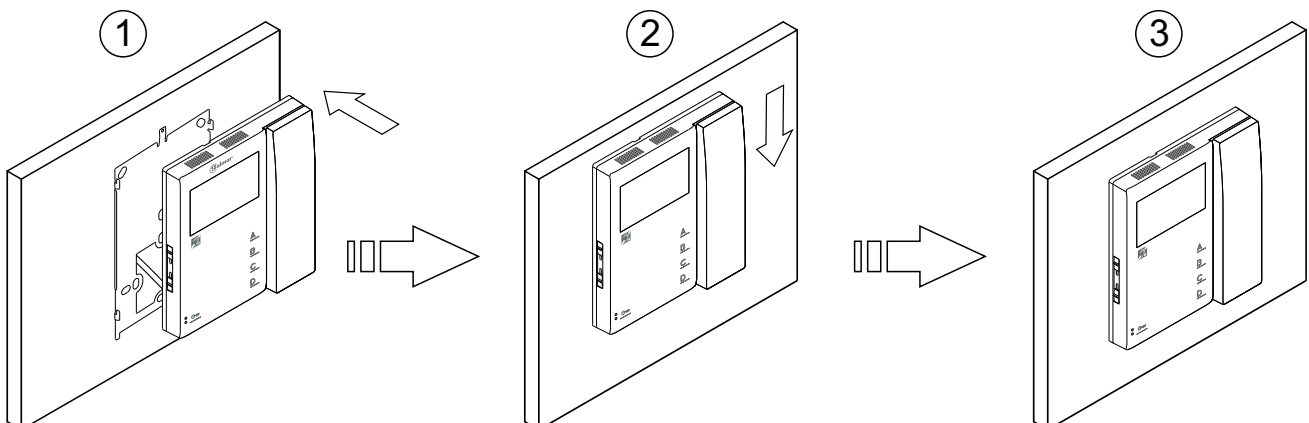

PROGRAMMING THE MONITORS

Programming the TEKNA S PLUS monitor:

Locate the SW2 DIP switch on the EL632 Plus sound module of the door panel or the EL500SE microprocessor and set to ON.
 In systems with more than one door panel, only perform this procedure on the main panel of each building.

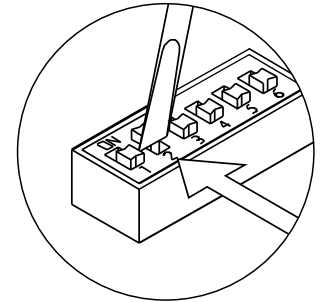

Important: To perform this programming, the monitor's SW1 DIP switch should be set to OFF.

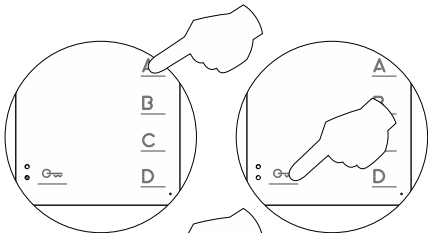

Turn off the monitor to be programmed (press button **A** for 3 seconds).
 Once switched off, press door release button **G**.

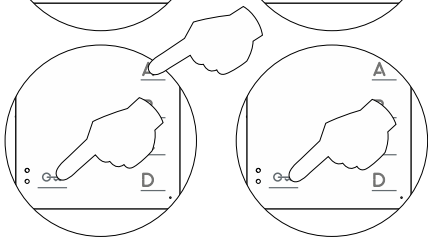

Press and hold door release button **G** and, without releasing it, switch on the monitor (press button **A** for 1 second).

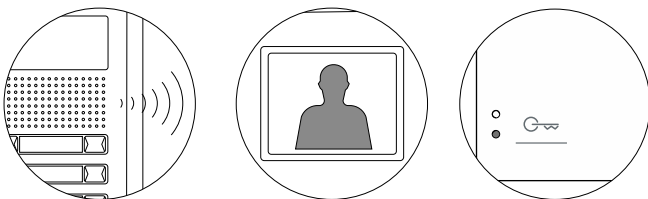

To show that the device is ready for programming, the door panel and monitor will emit a number of tones (the status LED on the monitor will illuminate red), enabling door release button **G** to be released. To establish audio communication with the door panel, lift the handset.

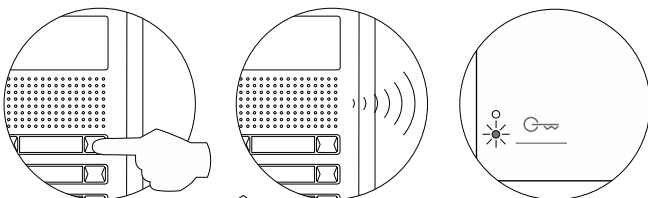

Press the door panel button that will call this monitor.
 At this moment, the door panel and monitor will emit a number of tones (the status LED on the monitor will blink red).

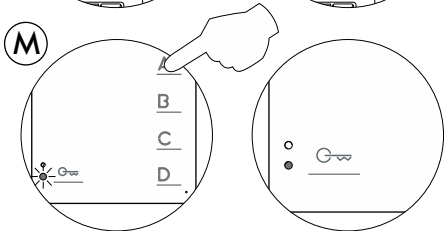

To programme the monitor as **Master**, press button **A** for 3 seconds (the monitor's LED will illuminate red).

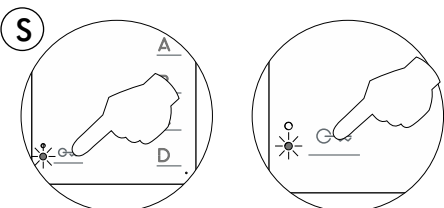

To programme it as **Slave 1**, press button **G** once and the status LED will blink (green) once. Continue successively to **Slave 4**, pressing button **G** four times and the status LED will blink (green) four times.

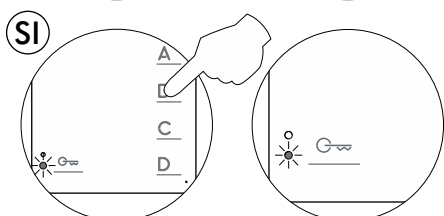

To programme it as **Slave + Intercom**, press button **B** and the LED will blink (green) once.

PROGRAMMING THE MONITORS

Continued from previous page.

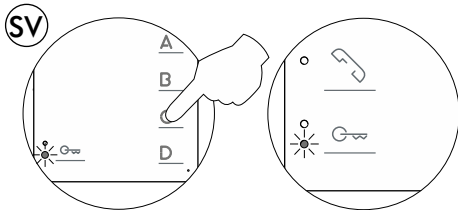

To programme it as **Slave without video** (in call), press button **C** and the status LED will blink (green) once. If button **C** is pressed again, the monitor will return to being programmed as **Slave with video** (in call) and the status LED will blink (green) twice. The door panel video will be displayed during a call if programmed to do so:

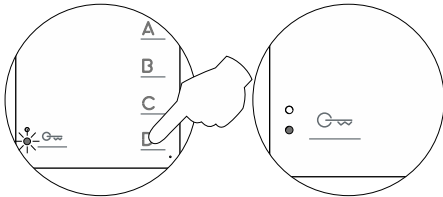

To exit, press button **D** (the monitor's LED will illuminate red).

Each apartment must only have one master unit; if there are parallel units, either monitors or telephones, they must be configured as slaves.

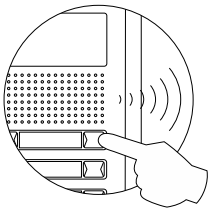

Make a call to check that the monitor has been successfully programmed. Programme the other monitors in the same way. Once the programming has finished, set the programming switch to OFF. If this is not done, the door panel will emit tones to indicate that the system is still in programming mode.

Quick programming of the Tekna S Plus monitors:

The SW1 DIP switch is located on the left-hand side of the back of the monitor. It enables the monitor to be configured as master/slave and an address to be assigned.

Important: This type of programming cannot be performed on a general entrance door panel.

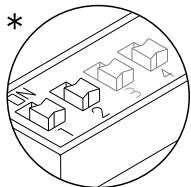
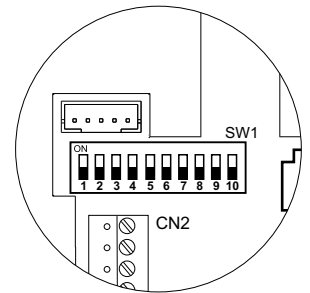

DIP 1 and DIP 2: Sets the monitor as master/slave + intercom. DIP 1 and DIP 2 to OFF master, DIP 1 to OFF and DIP 2 to ON slave 1, DIP 1 to ON and DIP 2 to OFF slave 2, DIP 1 and DIP 2 to ON slave 3.

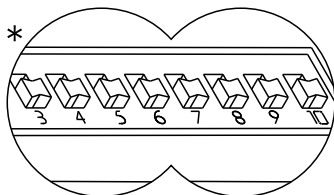

DIP 3 to DIP 10: To set the monitor address (addresses 1 to 255). The switches set to OFF have a zero value. The values of the switches set to ON are shown in the table below. The monitor code is the sum of the values of the switches set to ON.

Switch number:	3	4	5	6	7	8	9	10
Value when ON:	128	64	32	16	8	4	2	1

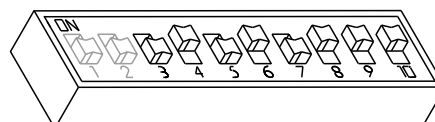

Example: 0+64+0+16+0+4+2+1=87

***Factory setting**

ADVANCED PROGRAMMING (MONITOR FUNCTIONS)

Advanced programming of the functions of the Tekna S Plus monitor:

Advanced programming enables the monitor's default settings to be changed:

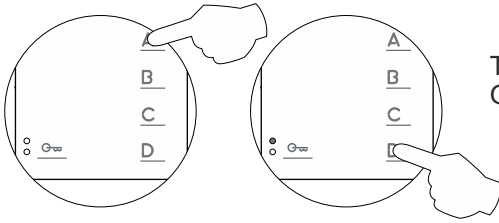

Turn off the monitor to be programmed (press button **A** for 3 seconds). Once switched off, press button **D** to access **'Menu 1'** of advanced programming and the programming LED will illuminate.

Menu 1:

Then adjust the settings as required:

- **Activating/deactivating the doctor mode function:** Doctor mode not activated (default setting).

The 'doctor mode' function enables the lock release to be activated automatically 6 seconds after making a call from the door panel without having to establish communication or press door release button **G-w**. The call ends after 20 seconds and the channel will become free.

(Only the master monitor should be configured with 'doctor mode').

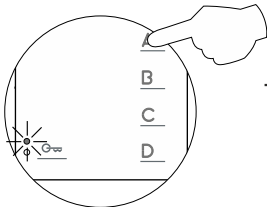

To activate doctor mode: Press button **A** and the programming LED will indicate with 2 blinks that the function is activated (the status LED will blink green) or with 1 blink that the function is deactivated.

- **Changing the ringtone melody:**

The monitor has different ringtones to identify the origin of the call. The melodies assigned by default to the ringtones can be selected from among others available on the monitor.

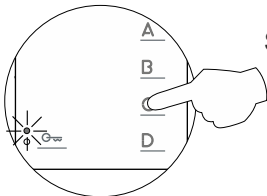

Select the ringtone to be changed: Each press on button **C** selects a ringtone which is indicated with blinks (1 to 4 blinks) of the programming LED and in the following order: door panel, guard unit, intercom call and 'HZ' apartment front door call. When the final selection is reached, the following press returns the user to the first selection and 1 blink of the programming LED (carousel mode).

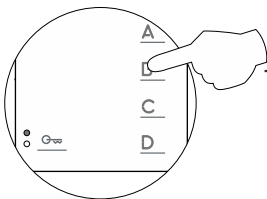

Then select the melody for the ringtone (selected in the previous step) by pressing button **B** until the required 'carousel mode' melody is heard.

- **Button **G-w** has no function.**

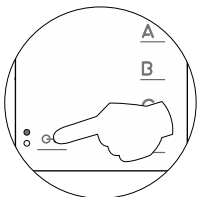

No function.

- **Accessing 'Menu 2' or exiting programming mode:**

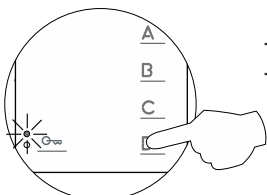

To access **'Menu 2,'** press button **D** and the programming LED will blink twice. To exit programming mode, press button **D** for 3 seconds, and the programming LED will turn off (see p. 15).

ADVANCED PROGRAMMING (MONITOR FUNCTIONS)

Continued from previous page.

Menu 2:

Then adjust the settings as required:

- Button **A** has no function.

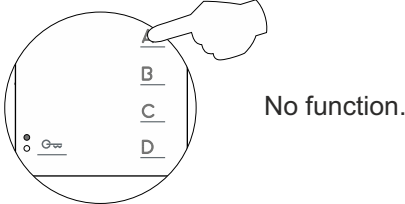

- Changing the function of button **B** : Intercom function (default setting).

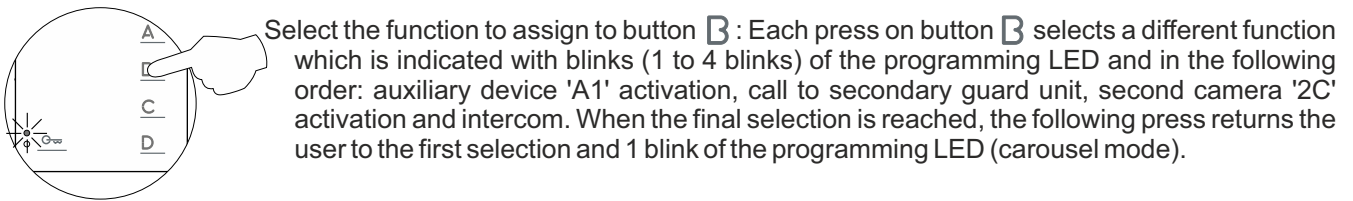

- Changing the function of button **C** : Activation of auxiliary device 'A1' function (default setting).

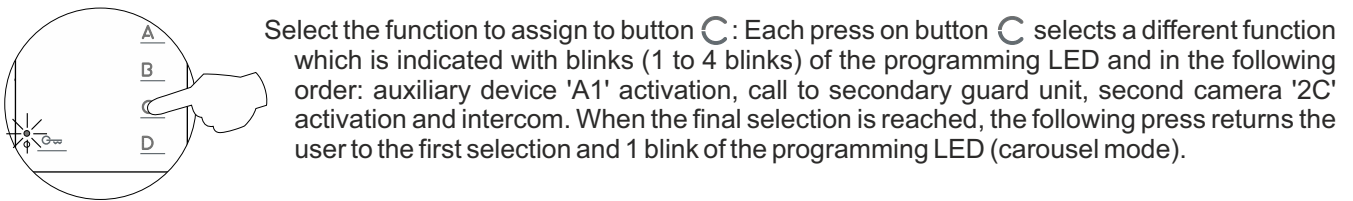

- Intercom with Tekna Plus monitors: Intercom with Tekna S Plus monitors (default setting).

If an apartment has Tekna Plus and Tekna S Plus monitors, the Tekna S Plus monitors should be configured with 'Intercom with Tekna Plus monitors' mode, as Tekna Plus monitors do not allow an intercom call to a particular monitor in the apartment to be made (selective intercom call). So when an intercom call is made, all of the monitors in the apartment will receive the call.

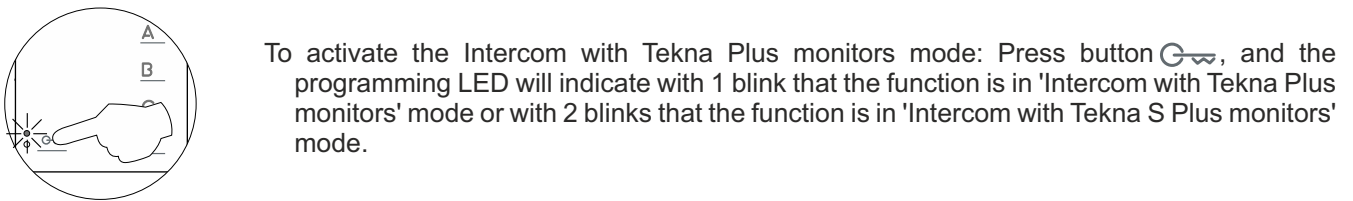

- Accessing 'Menu 3' or exiting programming mode:

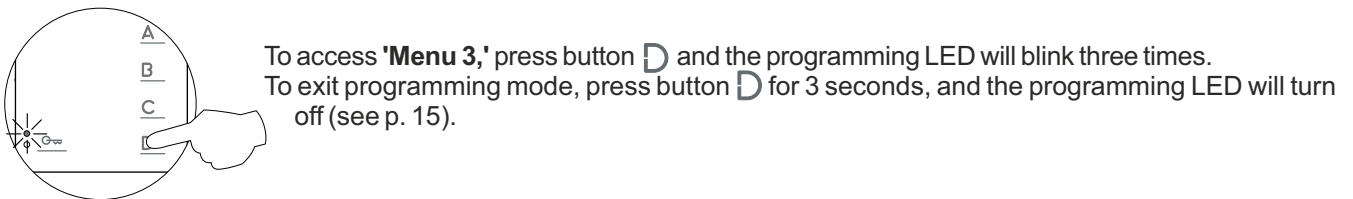

ADVANCED PROGRAMMING (MONITOR FUNCTIONS)

Continued from previous page.

Menu 3:

Then adjust the settings as required:

- **Repeating the ringtones:** One repeat (default setting).

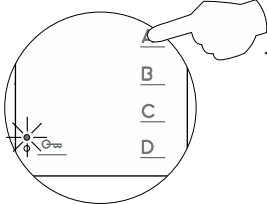

To 'repeat the ringtone' on the monitor: Each press on button **A** selects a repeat of the ringtones which is indicated with blinks (1 to 3 blinks) of the programming LED and in the following order: 1, 2 or 3 repeats. When the final selection is reached, the following press returns the user to the first selection and 1 blink of the programming LED (carousel mode).

- **Setting the 'door panel communication time':** 90 seconds (default setting).

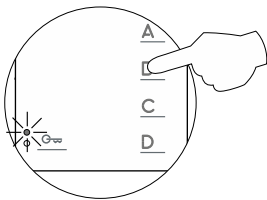

To set the 'door panel communication time': Each press on button **B** selects a communication time which is indicated with blinks (1 to 4 blinks) of the programming LED and in the following order: 60, 90, 120 and 150 seconds. When the final selection is reached, the following press returns the user to the first selection and 1 blink of the programming LED (carousel mode). **Note:** This setting can be performed on Nexa door panels with the EL632 Plus and EL632 Plus P/T sound module. (Please consult our technical service department for information about other models of door panel).

- **Setting the 'door panel call' time:** 45 seconds (default setting).

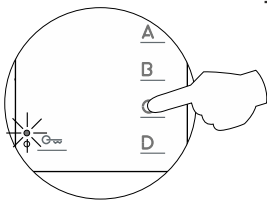

To set the 'door panel call' time: Each press on button **C** selects a call time which is indicated with blinks (1 to 4 blinks) of the programming LED and in the following order: 30, 45, 60 and 90 seconds. When the final selection is reached, the following press returns the user to the first selection and 1 blink of the programming LED (carousel mode). **Note:** This setting can be performed on Nexa door panels with the EL632 Plus and EL632 Plus P/T sound module. (Please consult our technical service department for information about other models of door panel).

- **Activating the in-call video:** The video appears when a call is received (default setting).

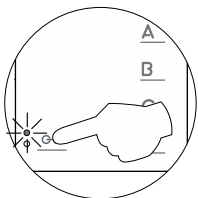

Activating the in-call video: Press button **G** and the programming LED will indicate with 2 blinks that the video will appear on the monitor when a call is received or with 1 blink that the video will appear at the end of the ringtone.

- **Accessing 'Menu 4' or exiting programming mode:**

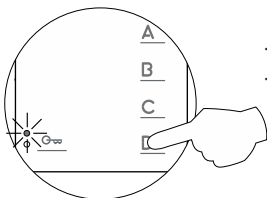

To access 'Menu 4,' press button **D**, and the programming LED will blink 4 times. To exit programming mode, press button **D** for 3 seconds, and the programming LED will turn off (see p. 15).

ADVANCED PROGRAMMING (MONITOR FUNCTIONS)

Continued from previous page.

Menu 4:

Then adjust the settings as required:

- **Setting to the 'default setting'** all of the monitor's advanced programming options:

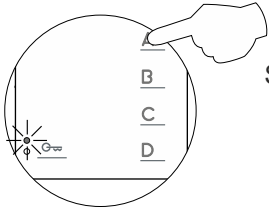

Setting to the 'default setting': Press button **A** and the monitor will indicate with two audible tones that all of the options of the monitor's advanced programming (pp. 12-15) are set to their default setting.

- **Button B** has no function.

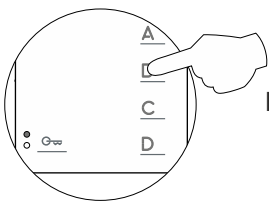

No function.

- **Button C** has no function.

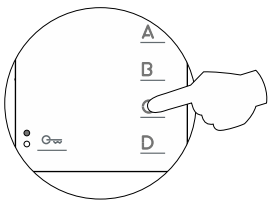

No function.

- **Button G** has no function.

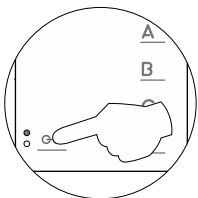

No function.

- **Accessing 'Menu 1' or exiting programming mode:**

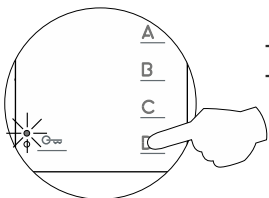

To access 'Menu 1,' press button **D**, and the programming LED will blink once (see p. 12). To exit programming mode, press button **D** for 3 seconds and the programming LED will turn off.

- **Turning on the monitor when exiting programming:**

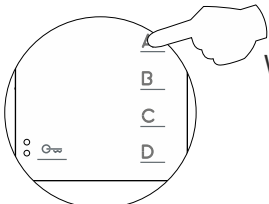

When exiting advanced programming mode, the monitor will turn off: Press button **A** for 1 second to turn on the monitor (the monitor's LED will illuminate red). After any resetting of the monitor and for the following 45 seconds, no operation with it can be performed.

OPTIONAL CONNECTIONS

Activating auxiliary devices with Tekna S Plus monitors:

Auxiliary device activation requires the use of an SAR-12/24 relay unit. If the feature is shared by all monitors, connect their A1 terminals; if, however, each monitor has its own feature, use an SAR-12/24 relay for each one and do not connect their A1 terminals.

This function is activated when button C is pressed on the monitor at any time and regardless of the position of the handset.

The most common applications are activating the stairway lights and opening a second door.

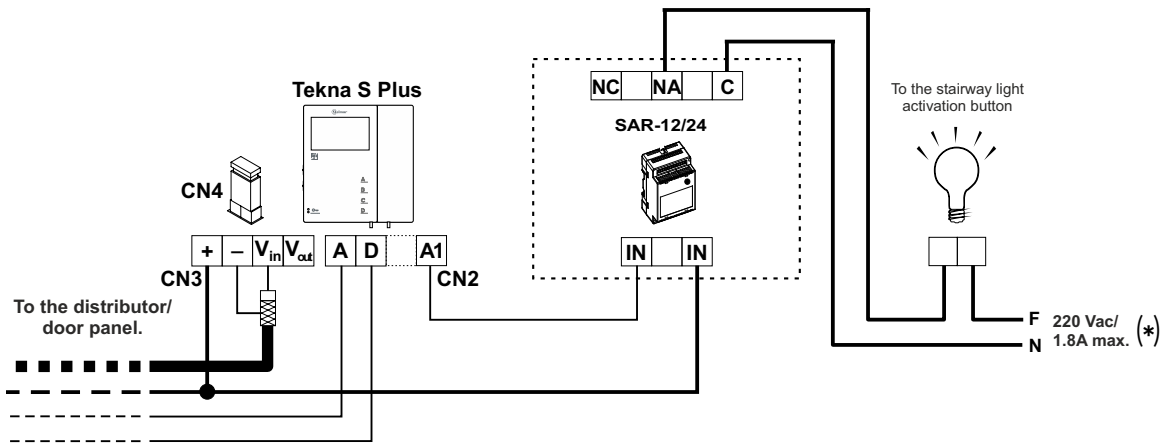

(*) The neutral of the lighting power supply is arranged serially through the contacts of the SAR-12/24 relay and the maximum consumption of the element to be connected does not exceed 1.8A.

To activate a second lock release, a TF-104 transformer is required.

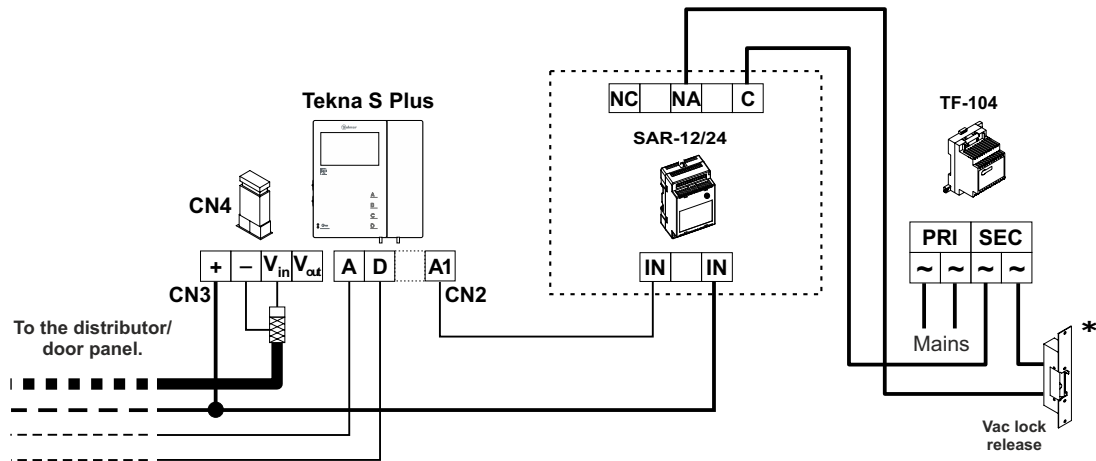

* **Important:** Place the varistor supplied with the sound module directly onto the terminals of the lock release.

Input for outside button to activate the door panel lock release:

This enables the door panel lock release to be activated during a call or communication with the door panel. With the monitor in standby, it makes a panic call to the guard units configured to receive such calls.

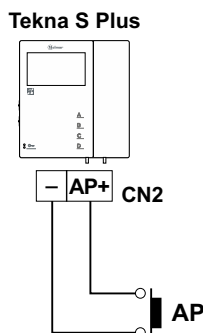

Continued overleaf

OPTIONAL CONNECTIONS

Continued from previous page.

Intercom between two points in the same apartment:

The Tekna S Plus monitor features as standard an intercom function between two points in the same apartment. To enable this function, the following is necessary:

- One of the monitors needs to be configured as master and the other as slave with intercom, as described on p. 10. In the case of intercom between a monitor and a telephone, it is recommended to configure the monitor as the master.
- The INT terminals of the intercom devices need to be joined (see diagram below).

To use the intercom function to call all of the monitors in the apartment, lift the handset and press the button until a confirmation tone can be heard. To call individual devices, press the button once to call the 'master' monitor, twice to call 'slave 1,' 3 times to call 'slave 2,' 4 times to call 'slave 3' and 5 times to call 'slave 4.' This selective intercom call mode is only available with Tekna S Plus, Tekna HF Plus and Tekna Plus SE monitors. This only functions if no call or communication is in progress. A number of audible tones emitted by the handset will confirm that the call is being made or that the unit being called is in communication with the door panel. To establish communication, lift the handset of the unit being called. If a call is received from the door panel during an intercom process, the handset of the master unit will emit a number of audible tones and an image will appear; to establish communication with the door panel, press button **D** on the unit configured as master or press the door release button to simply open the door.

The ringtones vary depending on where the call is being made from, enabling the user to identify its origin.

Remember: If the apartment also has Tekna Plus monitors, the Tekna S Plus, Tekna HF Plus and Tekna Plus SE monitors must be configured as 'Intercom with Tekna Plus monitors' (see p. 13). This configuration mode does not allow selective intercom calls to different monitors in the apartment; when the intercom button is pressed, all of the monitors in the apartment will receive the call.

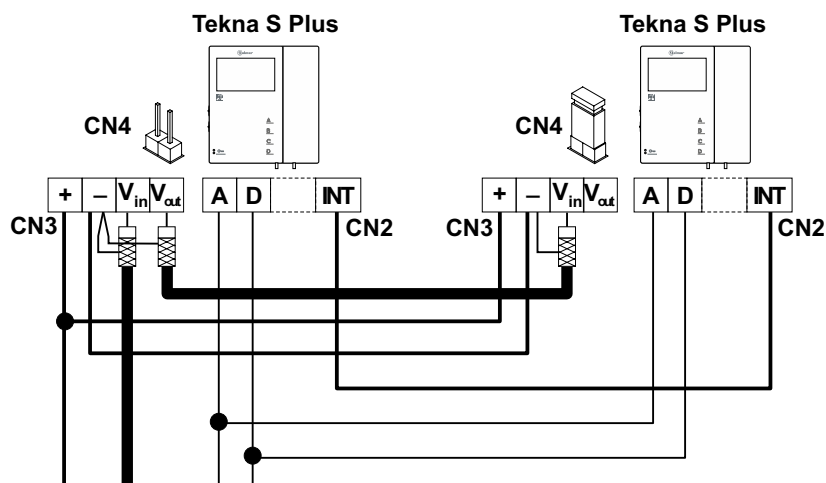

Button for receiving calls from the apartment front door:

The Tekna S Plus monitor features as standard the ability to receive calls from the apartment front door. This feature precludes the need to use the bell by positioning a button between terminals 'HZ—' and '—' of the monitor.

The ringtones vary depending on where the call is being made from, enabling the user to identify its origin. If a call is made from the apartment front door during a conversation with the door panel, the handset will emit a number of tones to indicate so.

Note: Regardless of the volume set for the monitor's ringtones (see p. 5) and the 'night mode' function, the 'apartment front door call' ringtone will always sound at the highest level.

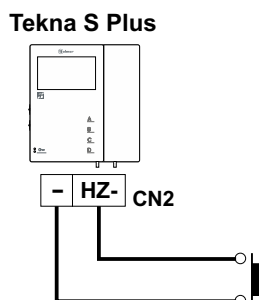

Continued overleaf

OPTIONAL CONNECTIONS

Continued from previous page.

Activating a second camera:

To activate a second camera, it is necessary to use an SAR-12/24 relay unit and to change the configuration of function button **B** or **C** on the monitor, as described on p. 13.

To activate this function, press the button configured for this function on the monitor during an auto-spy, call or communication process.

If the feature is shared by all monitors, join their 2C terminals; if, however, each monitor or a group of monitors has its own camera, use an SAR-12/24 relay for each one and do not connect the 2C terminals of the different groups.

This function can be used to activate anything else, as described in the section on activation of auxiliary devices, but through the 2C terminal.

The most common applications could be to monitor access to the lift, to the entrance hall, etc.

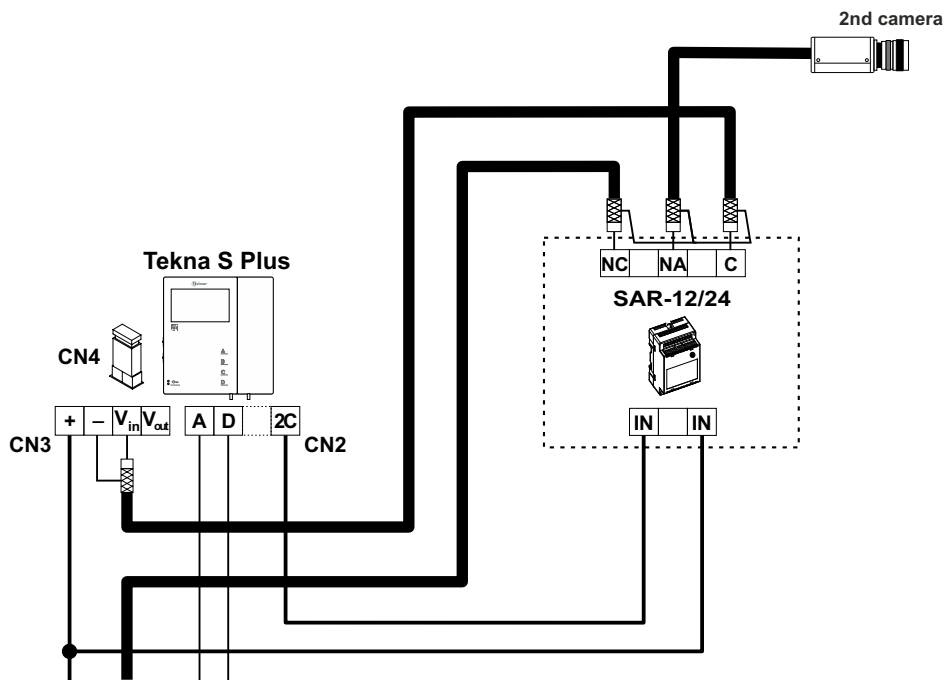

CLEANING THE MONITOR

- Do not use solvents, detergents or cleaning products that contain acids, vinegar or abrasive components.
- Use a soft damp lint-free cloth with water.
- Always wipe the monitor in the same direction, from top to bottom.
- After cleaning the monitor, remove any moisture with a soft dry lint-free cloth.

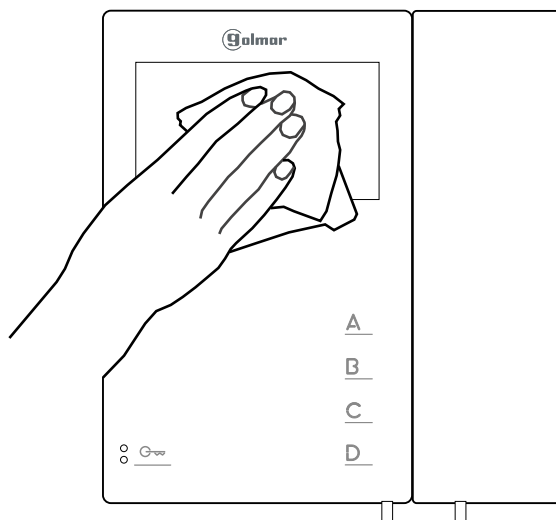

WIRING DIAGRAMS

Video door entry system with coaxial cable:

Remove the JP1 jumper from all of the distributors except the last.

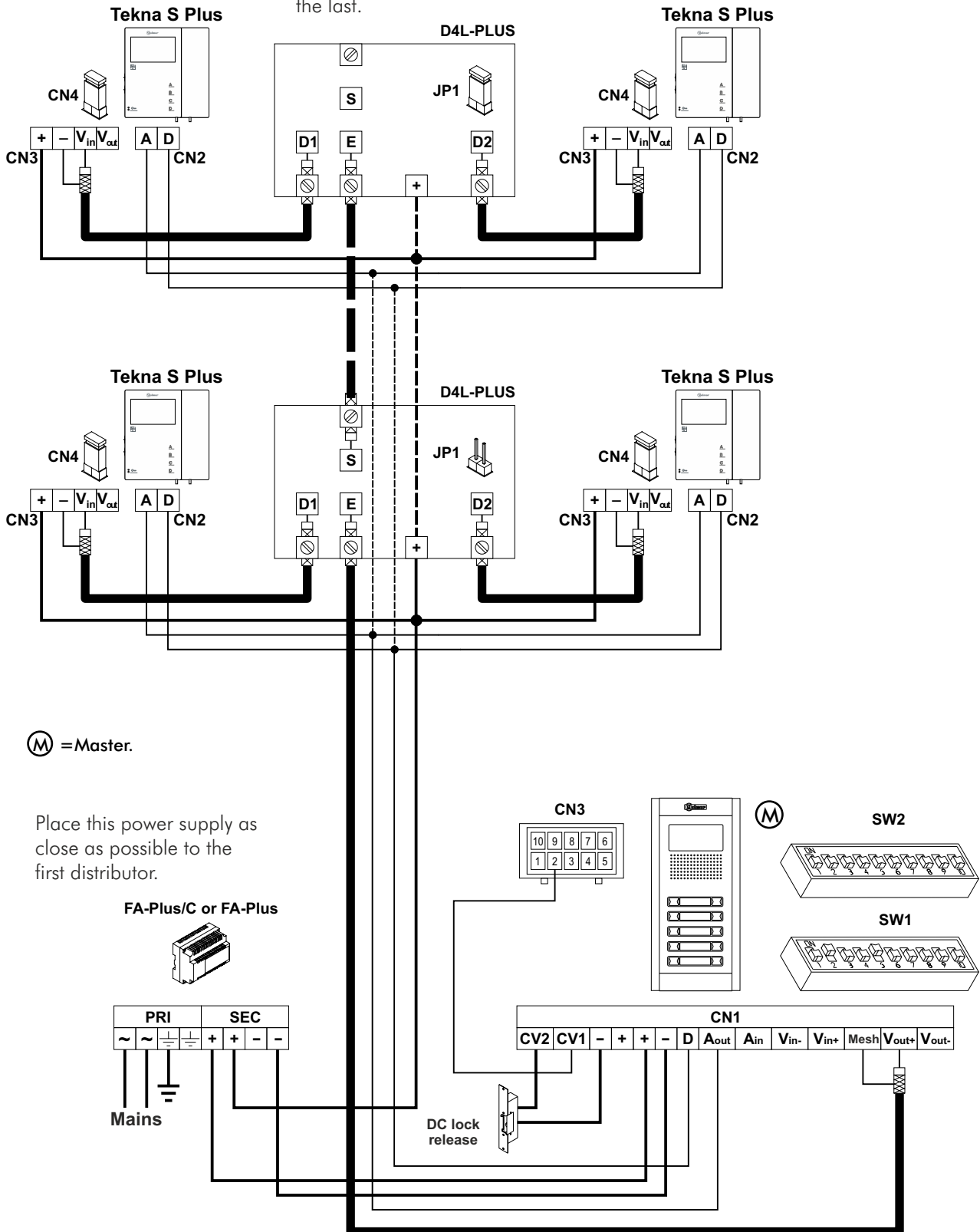

(M) = Master.

Place this power supply as close as possible to the first distributor.

Important:

For further information about the door panel, sections, distances, wiring diagrams, etc., see the T632 PLUS P/T manual. <https://doc.golmar.es/search/manual/50122328>

WIRING DIAGRAMS

Video door entry system without coaxial cable:

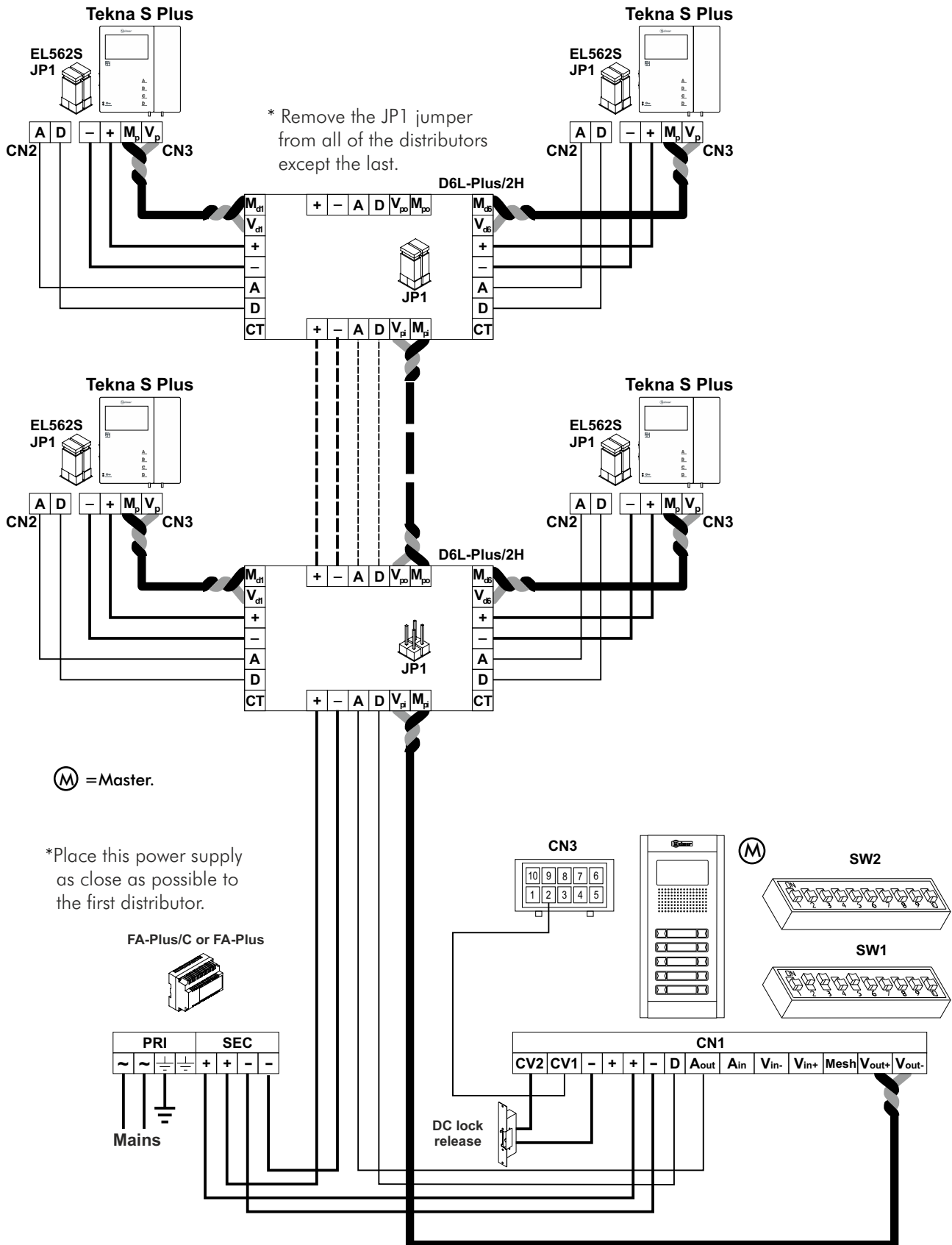

Important:

For further information about the door panel, sections, distances, wiring diagrams, etc., see the T632 PLUS P/T manual. <https://doc.golmar.es/search/manual/50122328>

NOTES:

Dotted lines for writing notes.

COMPLIANCE

Este producto es conforme con las disposiciones de las Directivas Europeas aplicables respecto a la Seguridad eléctrica **2014/35/CEE** y la Compatibilidad Electromagnética **2014/30/CEE**.

*This product meets the essentials requirements of applicable European Directives regarding Electrical Safety **2014/35/ECC**, Electromagnetic Compatibility **2014/30/ECC**.*



NOTA: El funcionamiento de este equipo está sujeto a las siguientes condiciones:

(1) Este dispositivo no puede provocar interferencias dañinas, y (2) debe aceptar cualquier interferencia recibida, incluyendo las que pueden provocar un funcionamiento no deseado.

NOTE: Operation is subject to the following conditions:

(1) This device may not cause harmful interference, and (2) this device must accept any received interference, including the ones that may cause undesired operation.



golmar@golmar.es

www.golmar.es

GOLMAR S.A.
C/ Silici, 13
08940- Cornellá de Llobregat
SPAIN



Golmar se reserva el derecho a cualquier modificación sin previo aviso.

Golmar se réserve le droit de toute modification sans préavis.

Golmar reserves the right to make any modifications without prior notice.